

## PORTACANNE

Portacanna in nylon ad incasso dritto utilizzabile anche da riposo

**28.28027** Colore nero

**28.28028** Colore bianco

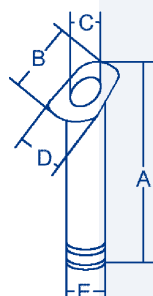

Portacanna in nylon ad incasso, completo di tappo copriforo

BIANCO	NERO	A	B	C	D	E
<b>28.28205</b>	<b>28.28204</b>	273	102	44	88	53

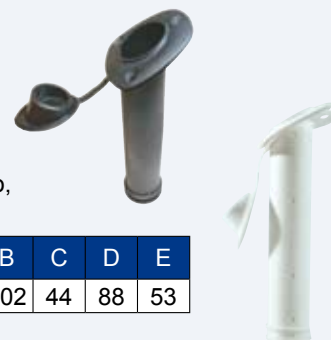

Portacanna ad incasso completo di tappo copriforo

Ottone Cromato	Inox AISI 316	A	B	C	D	E
<b>28.28001</b>	<b>28.28002</b>	240	113	44	90	50



Portacanna in acciaio inox **AISI 316** con ponticello reggicanna, completo di tappo copriforo.

Articolo	A	B	C	D	E
<b>28.28003</b>	280	110	44	80	50



Portacanna in nylon nero con **ghiera esterna a vista in acciaio inox AISI 316** completo di tappo copriforo.

Articolo	A	B	C	D	E
<b>28.28220</b>	275	103	44	92	53



Portacanna in acciaio inox sfilabile.

Articolo	Base mm.	Ø mm.	lung. mm.
<b>28.28015</b>	120 x 82	40	240

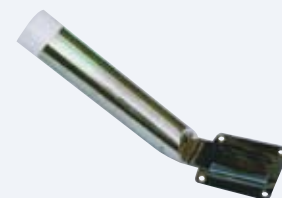

Tappo in PVC morbido per portacanna per art. 28.28001

**28.28010** nero

**28.28011** bianco



**28.28012**

Boccola in gomma con tappo Ø interno mm. 40 esterno mm. 49 per portacanne ad incasso art. 28.28001/2/3



Portacanna orientabile in ottone cromato

Articolo	Base mm.	Ø mm.	lung. mm.
<b>28.28033</b>	90 x 63	33	200
<b>28.28040</b>	90 x 63	40	250



Ricambi per portacanna 28.28033/040

**28.28045** molla

**28.28046** base

**28.28047** rondella

**28.28048** galletto

**28.28049** boccola per 28.28040/1 /58/62/90/102/103

**28.28050** boccola per 28.28033



Portacanna orientabile in ottone cromato, viti a scomparsa

Articolo	Base mm.	Ø mm.	lung. mm.
<b>28.28041</b>	100 x 67	40	250

Ricambi per art. 28.28041

**28.28045** molla

**28.28051** galletto

**28.28052** rondella

**28.28053** base



Portacanna in ottone cromato orientabile, per battagliole e pulpiti

Articolo	Ø mm.	lung. mm.	Tube Ø mm.
<b>28.28058</b>	40	290	22/25/30



Portacanna in ottone cromato orientabile per battagliole e pulpiti

Articolo	Ø mm.	lung. mm.	Tube Ø mm.
<b>28.28062</b>	40	290	20/22/25/30



## PORTACANNE



Portacanna in ottone cromato orientabile con morsetto per applicazione su specchio di poppa. Apertura morsetto mm. 100.

Articolo	Ø mm.	lung. mm.
28.28090	40	250

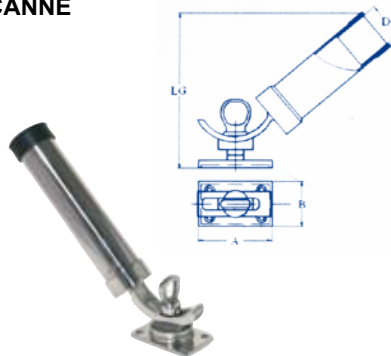
**28.28102**

Portacanna orientabile in acciaio inox AISI 316.

LG	D	A	B
340	40	89	55

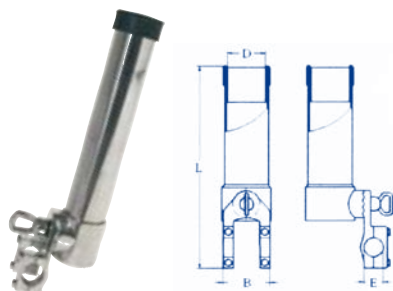
**28.28103**

Portacanna orientabile in acciaio inox AISI 316.

L	D	B	E
360	40	65	25,5

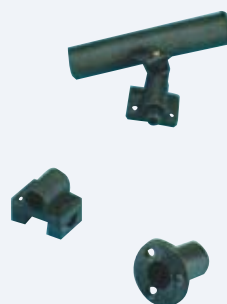
**28.28054**

Portacanna orientabile in nylon nero snodabile completo di 3 attacchi, per montaggio laterale, verticale o su pulpito

**28.28059** Ricambio basetta laterale

**28.28060** Ricambio basetta da incasso

**28.28056**

Portacanna orientabile in nylon nero, attacco a parete a baionetta. Può ruotare ed essere bloccato per 360° in senso orizzontale e per 140° dalla posizione orizzontale a quella verticale. La canna resta incastrata tramite il mulinello, nell'apposito incavo ricavato nel portacanna. Anello superiore di blocco della canna.

**28.28057**

Basetta "ad incasso" in nylon nero per montare il portacanna 28.28056 in coperta anziché a parete.

**28.28065**

Portacanna fisso da parete. Possono servire anche come portacanne da riposo

Articolo	descr.	Ø mm.	lung. mm.
28.28065	OTTONE CROMATO	40	250
28.28070	NERO	40	225
28.28071	BIANCO	40	225

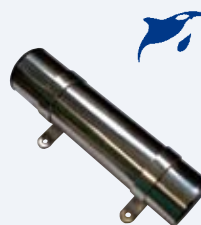

Portacanna in acciaio inox fisso da parete. Senza spina interna portacanna. Può servire anche come portacanne da riposo.

Articolo	Ø mm.	lung. mm.
28.28067	40	210

**28.28100**

Portacanna oscillante in ottone cromato. Per poltrone da combattimento per tubo Ø mm. 22/25. Dim. mm. 80 x100.

**28.28095**

Supporto per 3 canne, fissaggio orizzontale o verticale, costruito in nylon nero con interno in neoprene morbido. Venduti a coppia. Base mm. 198x62, sporgenza mm. 71.

**28.28096**

Reggicanna a soffitto o parete in nylon



Portacanna a parete in PVC bianco

Articolo	Posti	A	B	C
28.28332	2	220	70	9
28.28334	4	380	70	9

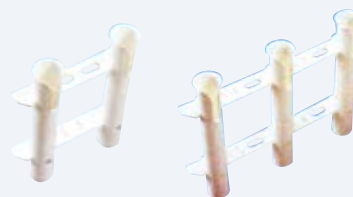

Portacanna a parete in PVC bianco

Articolo	Posti	A	B	C
28.28342	2	270	30	6,5
28.28343	3	440	30	6,5

